

ALUMINIUM RAILS

Manufacturing Relationships
Distributing Quality





 **DIOS**
INDIA
IT IS FOREVER

Top Mounting Continuous Profile

- Easy Installation
- Weather Proof
- Sturdy Support
- Standard Quality



01A000

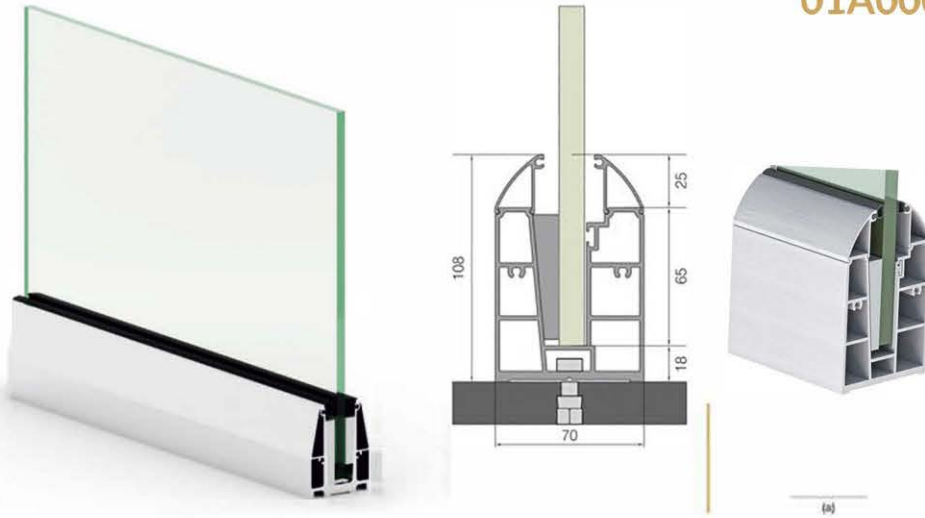

01A002

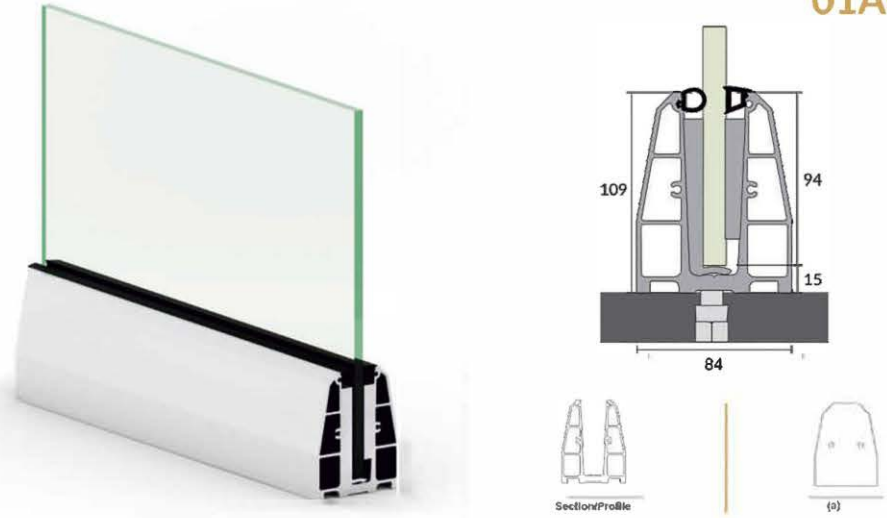

01A003

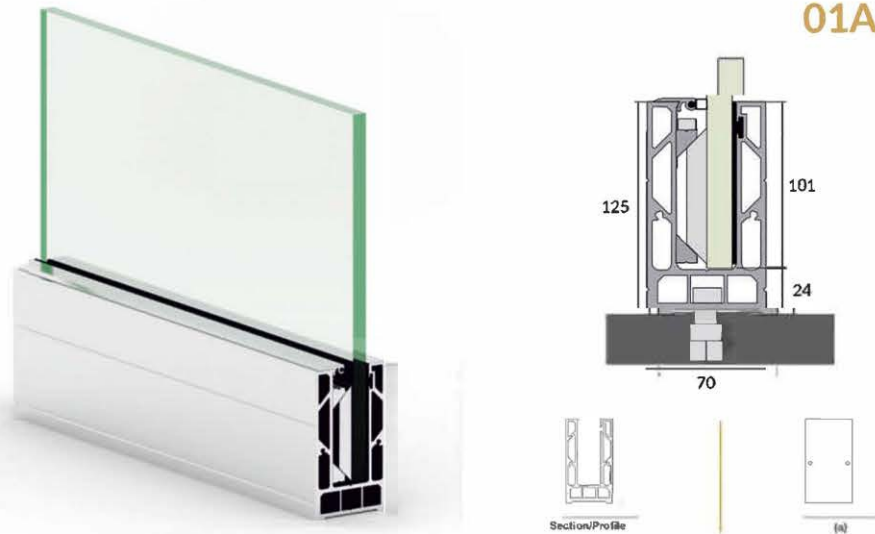

01A004

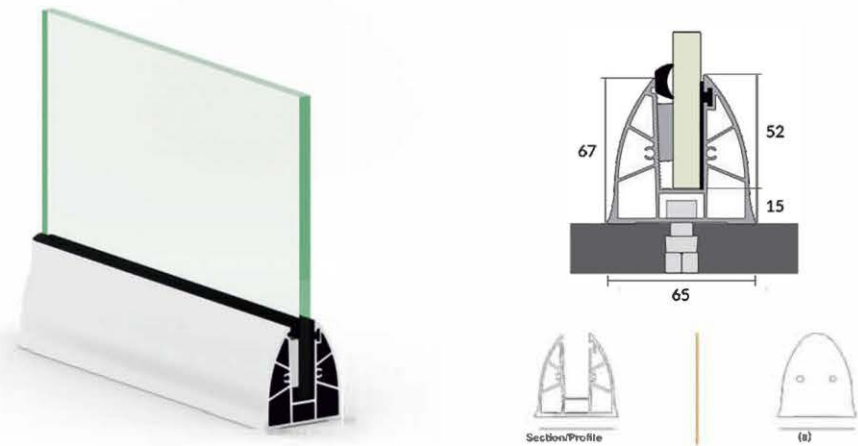

Top Mounting Continuous Profile

-  Easy Installation
-  Weather Proof
-  Sturdy Support
-  Standard Quality



01A005

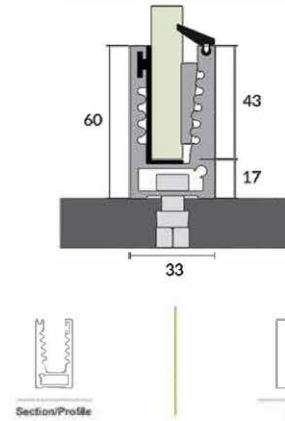

01A006

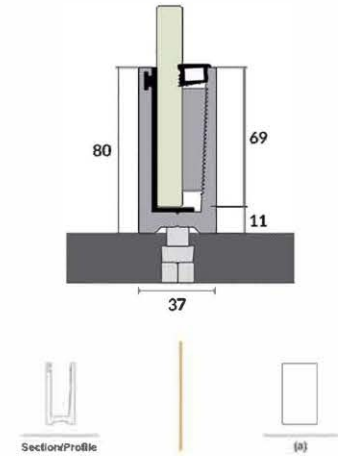

01A007

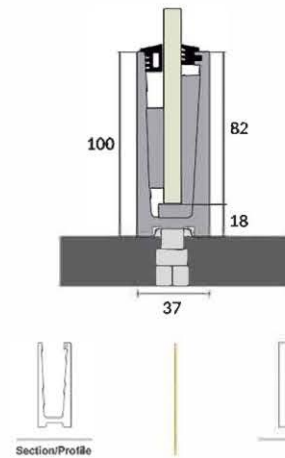

01A008

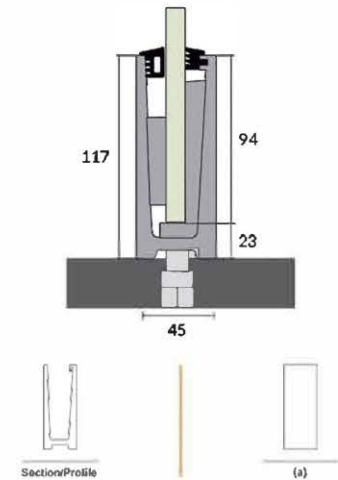

Top Mounting Continuous Profile

-  Easy Installation
-  Weather Proof
-  Sturdy Support
-  Standard Quality



01A009

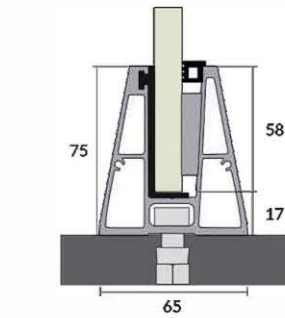

Section/Profile



(a)

01A010

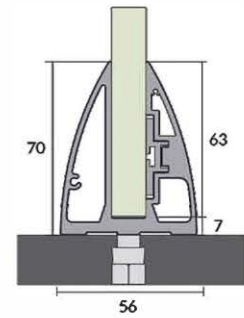

Section/Profile



(a)

01A011

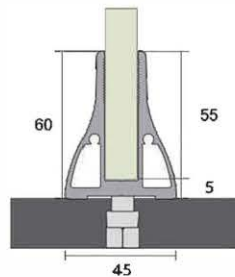

Section/Profile



(a)

01A012

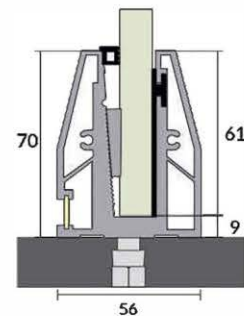

Section/Profile



(a)

Top Mounting Brackets with Continuous Cover

- Easy Installation
- Weather Proof
- Sturdy Support
- Standard Quality



02A001

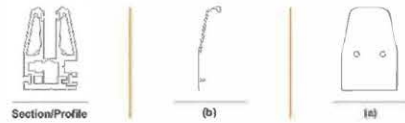
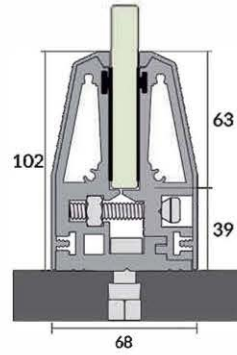

02A002

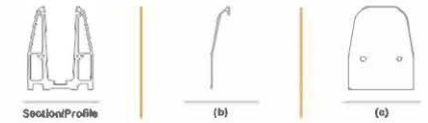
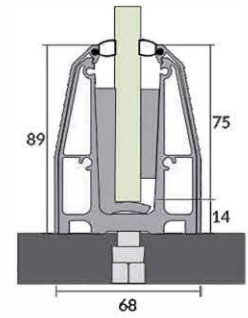

02A003

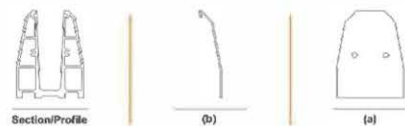
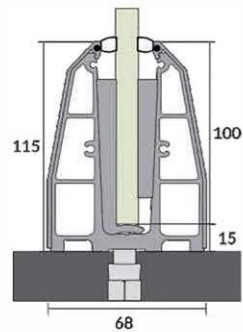

02A004

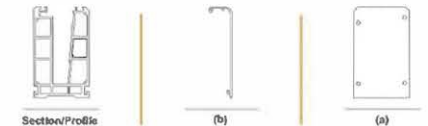
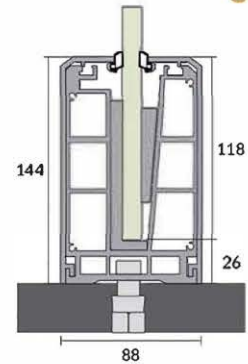

Top Mounting Brackets with Continuous Cover

-  Easy Installation
-  Weather Proof
-  Sturdy Support
-  Standard Quality

02A005

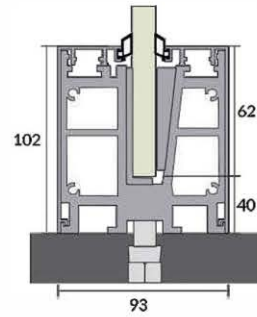

02A006

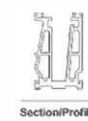
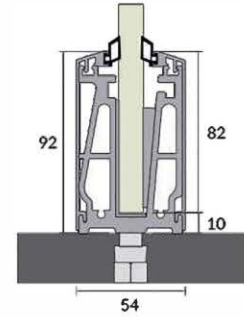

02A007

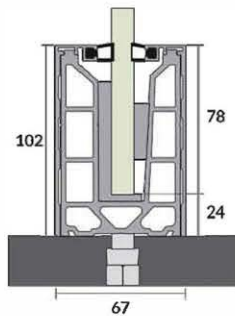

02A008

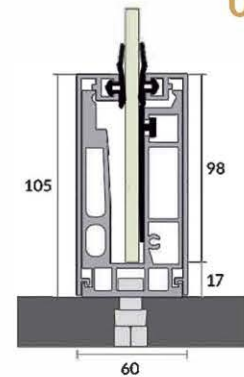



DIOS
INDIA
IT IS FOREVER

Top Mounting Brackets

-  Easy Installation
-  Weather Proof
-  Sturdy Support
-  Standard Quality



03A001



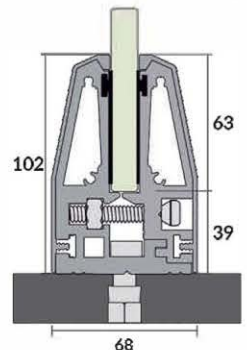



68



Section/Profile



(b)



(c)

03A002





65



Section/Profile



(c)

03A003



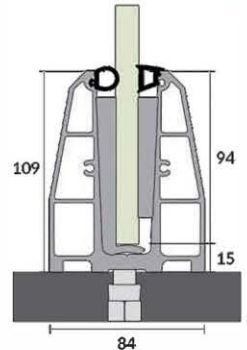

84



Section/Profile

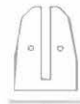

(c)

03A004



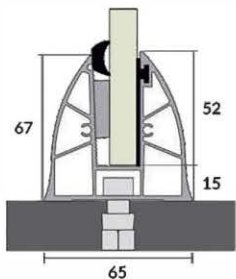

65



Section/Profile

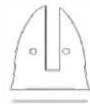

(c)

Top Mounting Brackets

-  Easy Installation
-  Weather Proof
-  Sturdy Support
-  Standard Quality

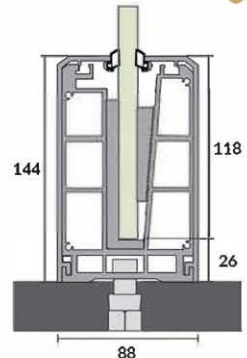

03A005

Section/Profile (b) (c)

03A006

Section/Profile (b) (c)

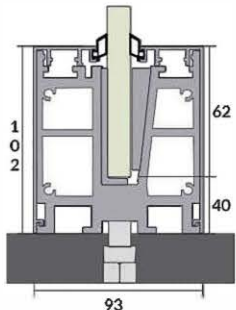
03A007



Section/Profile (b) (c)

03A008

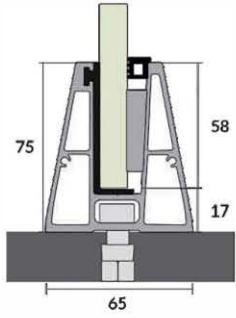
Section/Profile (b) (c)

Top Mounting Brackets

-  Easy Installation
-  Weather Proof
-  Sturdy Support
-  Standard Quality



03A009

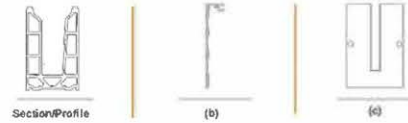
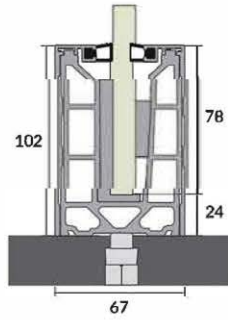

03A010

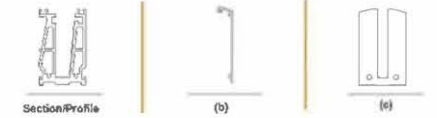
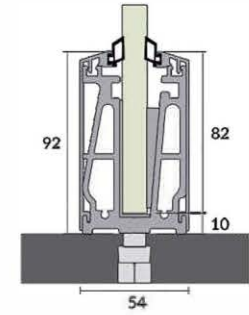

03A011

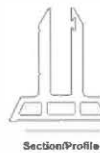
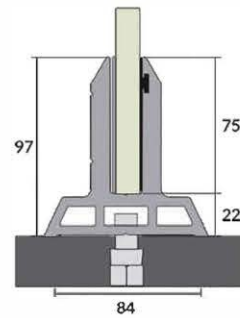

03A012

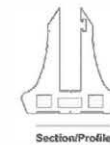
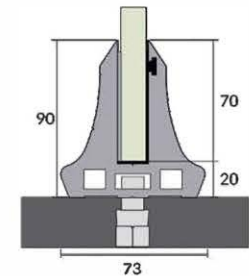

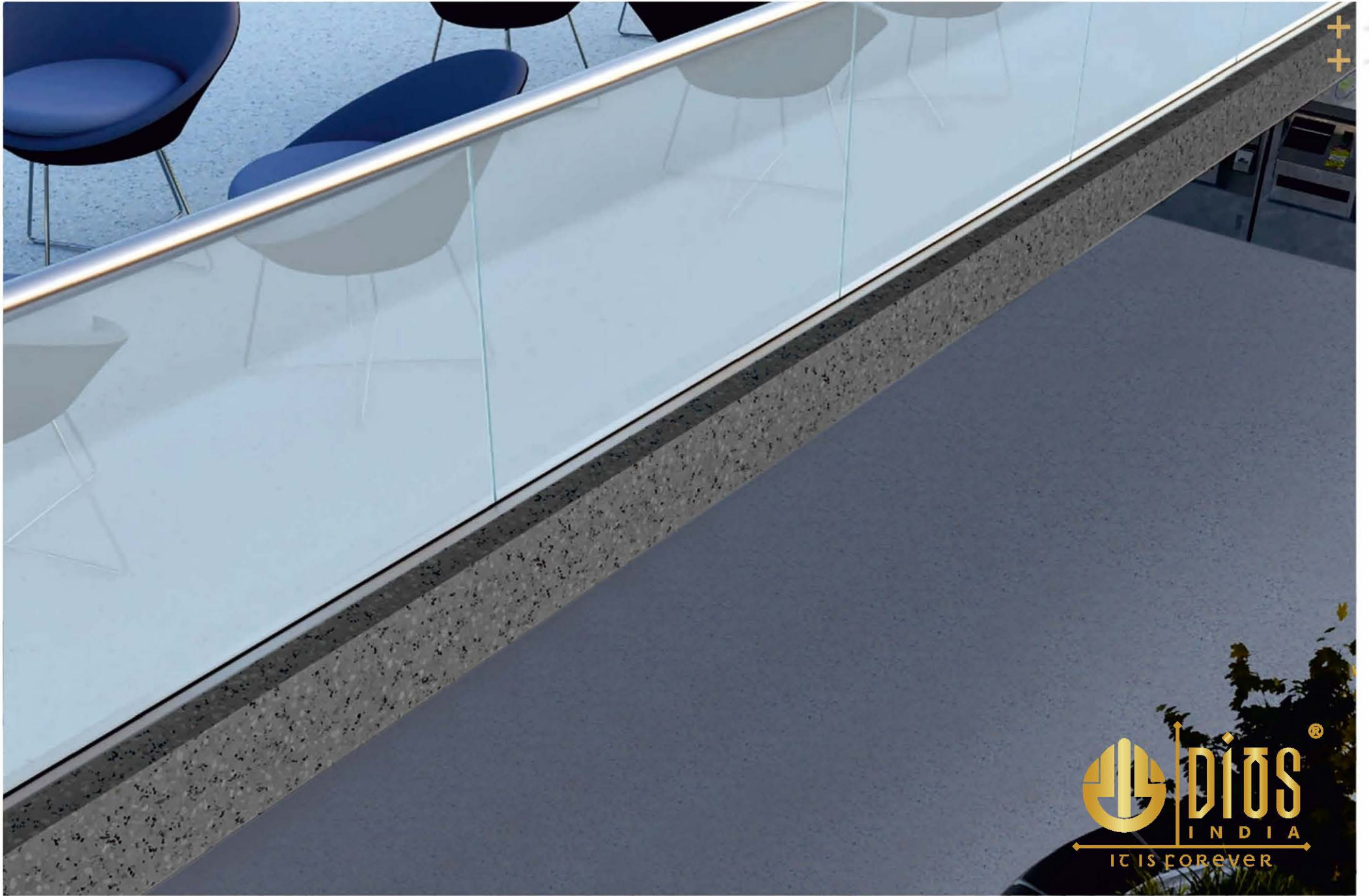

 **DINOS**
INDIA
IT IS FOREVER

Concealed & Facia Mount System

- Easy Installation
- Weather Proof
- Sturdy Support
- Standard Quality



04A001

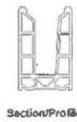
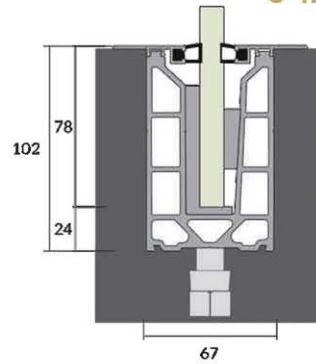

(a)

04A002

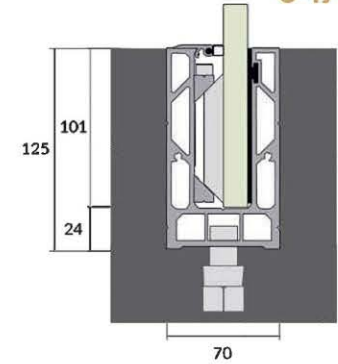

(a)

04A003

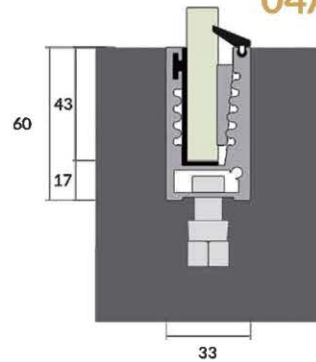

Section/Profile

(a)

05A001

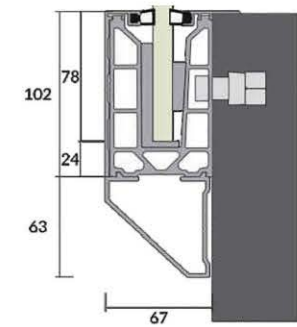

Section/Profile

(b)

(d)

(e)













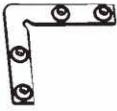

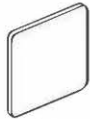

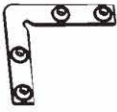



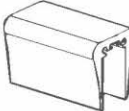
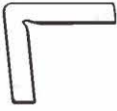

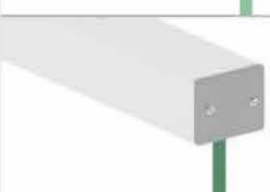
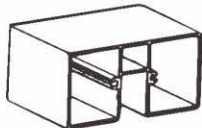
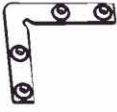

Aluminium Handrails

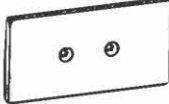
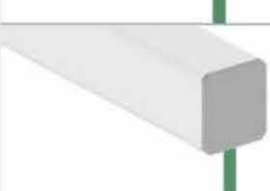
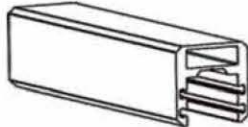
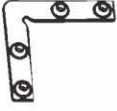
-  Easy Installation
-  Weather Proof
-  Sturdy Support
-  Standard Quality

	HANDRAIL	PROFILE	90° CONNECTOR	PIPE CONNECTOR	WALL CONCEAL	END CAP
06 A 001		 Ø65	 (a)	 (b)	 (c)	 (d)
06 A 002		 Ø50	 (a)	 (b)	 (c)	 (d)
06 A 003		 50 X 50	 (a)	 (b)	 (c)	 (d)
06 A 004		 40 X 40	 (a)	 (b)	 (c)	 (d)
06 A 005		 66 X 39	 (a)	 (b)	 (c)	 (d)
06 A 006	 LED	 71X35 mm	 (a)	 (b)	 (c)	 (d)

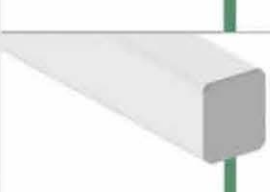
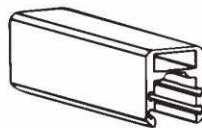
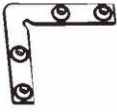
Aluminium Handrails

-  Easy Installation
-  Weather Proof
-  Sturdy Support
-  Standard Quality

	HANDRAIL	PROFILE	90° CONNECTOR	PIPE CONNECTOR	WALL CONCEAL	END CAP
06 A 007	 LED	 50X50mm	 (a)	 (b)	 (c)	 (d)
06 A 008		 82X38mm	 (a)	 (b)	 (c)	 (d)
06 A 009		 35X40mm	 (a)	 (b)	 (c)	 (d)
06 A 010		 60X45 mm	 (a)	 (b)	 (c)	 (d)
06 A 011		 25X25mm	 (a)	 (b)	 (c)	 (d)
06 A 012		 22X25mm	 (a)	 (b)	 (c)	 (d)



BRAND OF **IMPERIAL**
HARDWARE

SHOP No. 4, GROUND FLOOR, GOKULDHAM CHS,
32, KIKA STREET, GULAWADI, MUMBAI 400004.
EMAIL: WEASSIST@DIOSINDIA.IN
WEBSITE: WWW.DIOSINDIA.IN

CONNECT WITH US



@ DIOS.INDIA