

S.S RAILINGS

Manufacturing Relationships
Distributing Quality





ALUMINIUM
& STAINLESS STEEL
**GLASS RAILING
SYSTEMS**

 **DIOS**[®]
INDIA
IT IS FOREVER

Powder Coated Finish



Silver Grey



Anodic Bronze



Thunder Black

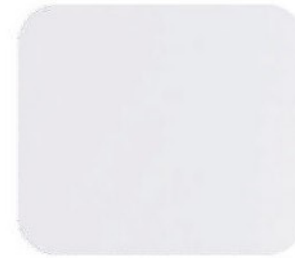

Semi Glossy
White



Silver Metallic

Wooden Finish



A



B



C



D



E

PVD Finish (Steel)



Rose Gold



Gold



Matt Black



Copper



Grey



Spigots

01S001

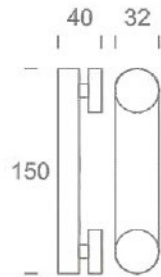

01S002

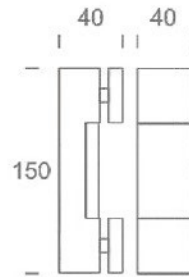

01S003

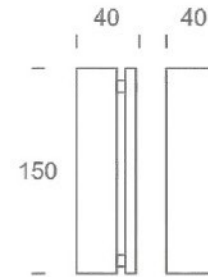

01S004

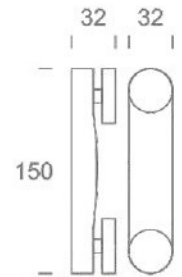

01S005



01S006



01S007



01S008





Spigots

01S009

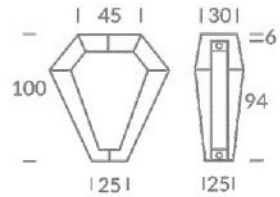

01S011

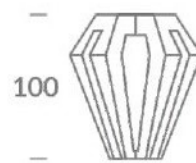

01S013

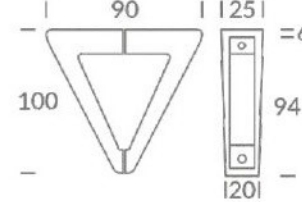

01S015

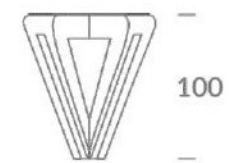

01S010

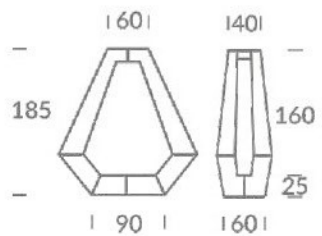

01S012

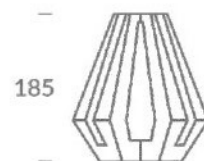

01S014

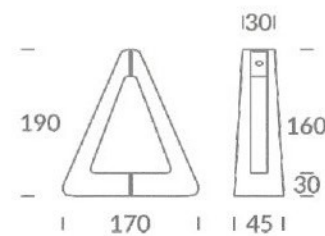

01S016

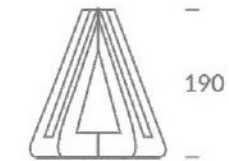



Spigots

01S017

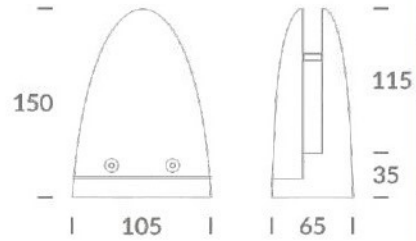

01S018

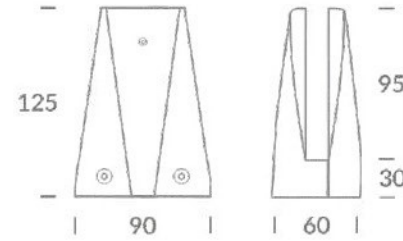

01S019

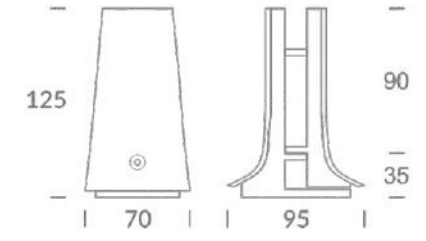

01S020

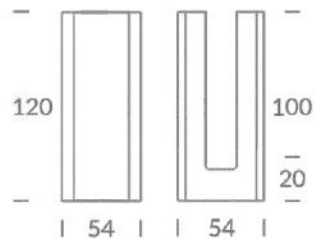

01S021

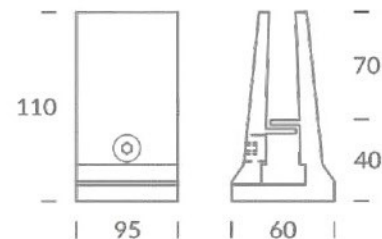

01S022

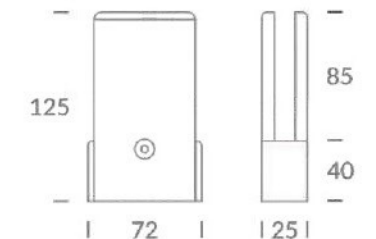



Spigots

01S023

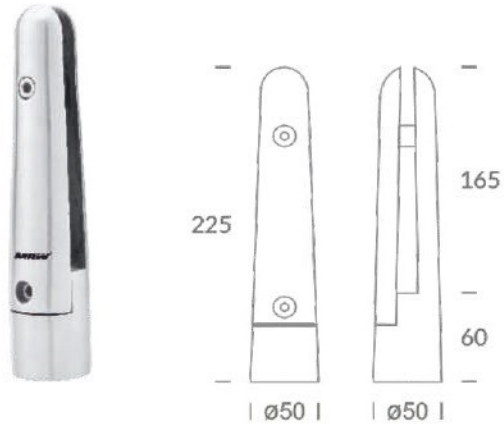

01S024

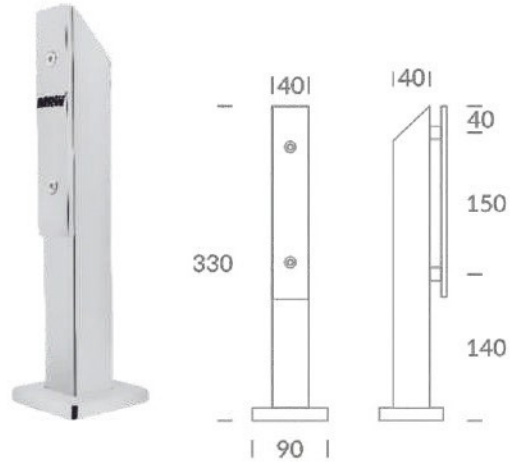

01S025



01S026



01S027

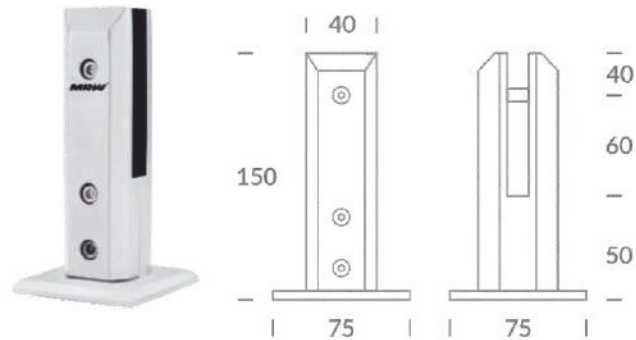

01S028

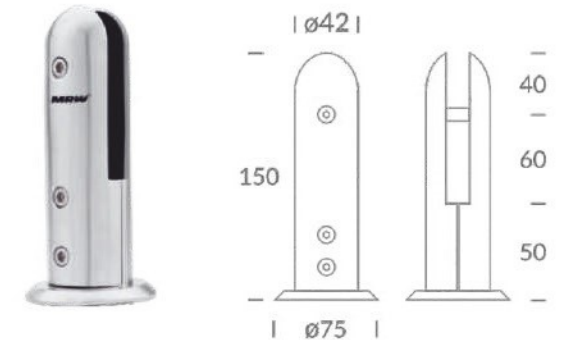

Spigots

01S029

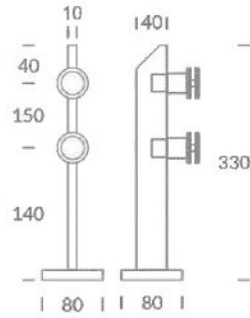

01S030

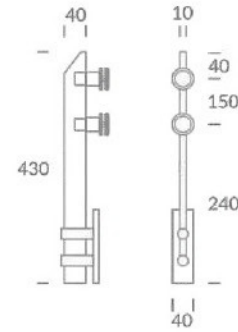

01S031

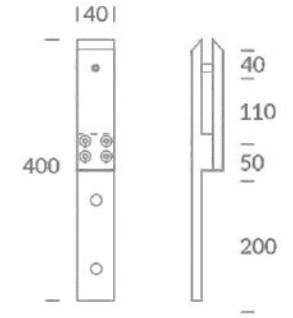

01S032

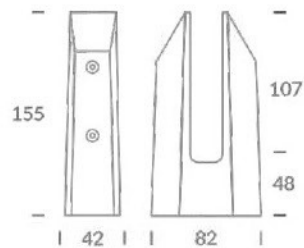

01S033

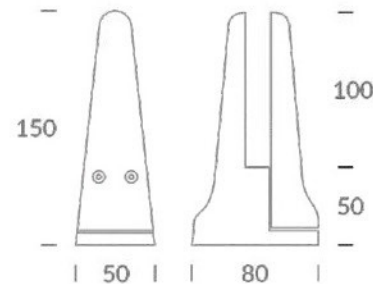

01S034

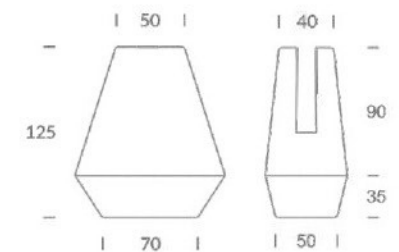

Spigots

01S035

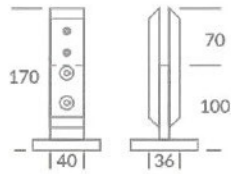

01S036

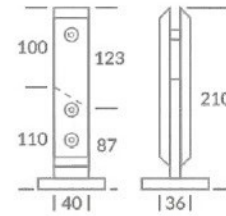

01S037

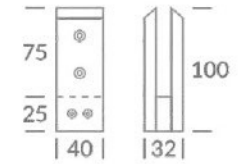

01S038

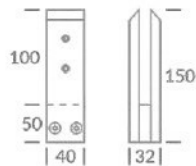

01S039

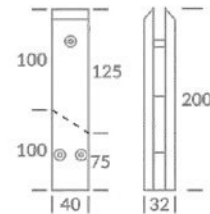

01S040

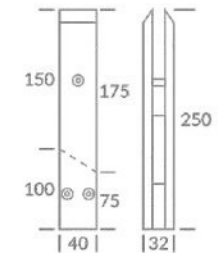



Balusters

02S001

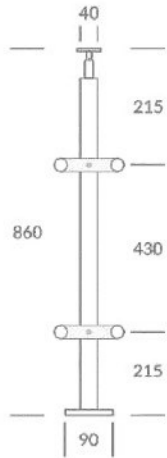

40X40X860 mm

02S002

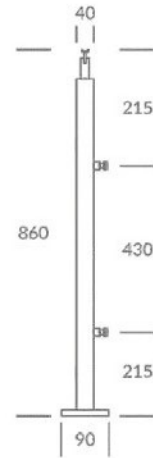

40X40X860 mm

02S003

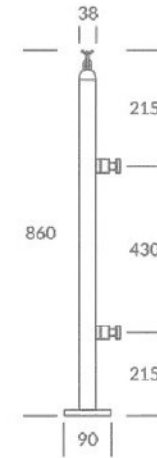

Ø38X860 mm

02S004

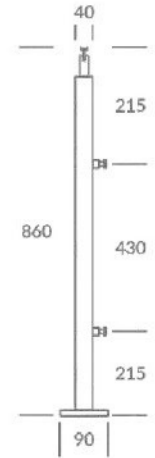

40X20X860 mm

02S005

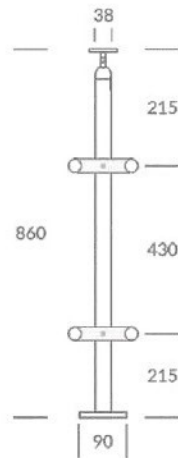

Ø38X860 mm

02S006

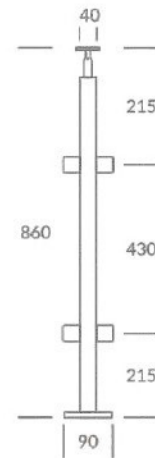

40X40X860 mm

02S007

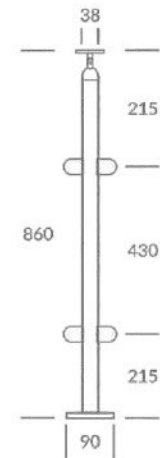

Ø38X860 mm



Balusters



02S008

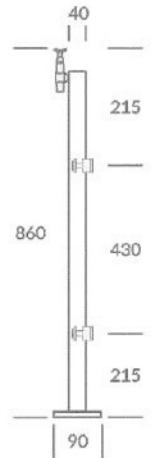

40X10X860 mm



02S009

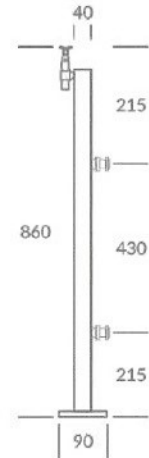

40X10X860 mm



02S010

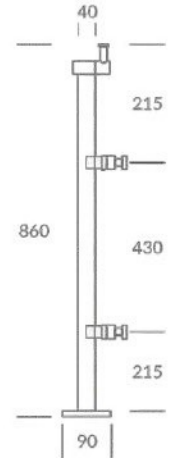

(SOLID) 40X10X860 mm



02S011

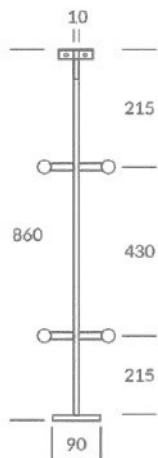

(SOLID) 40X10X860 mm



02S012

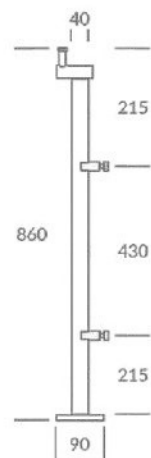

(SOLID) 40X10X860 mm



02S013

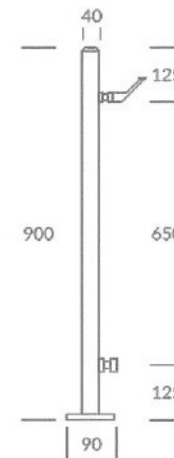

40X40X900 mm



02S014



25X50X850 mm



Balusters

02S015

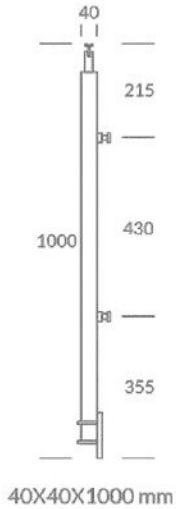

02S016

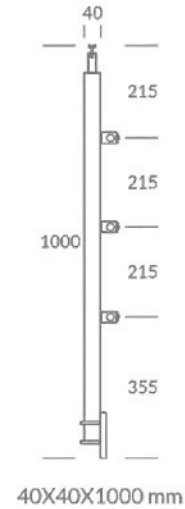

02S017

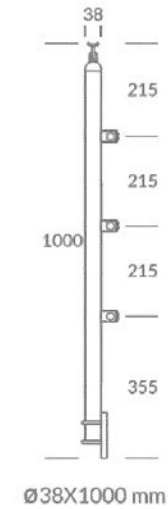

02S018

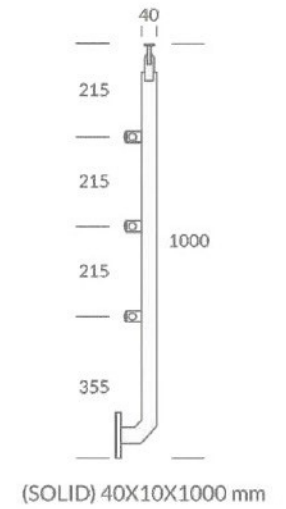

02S019

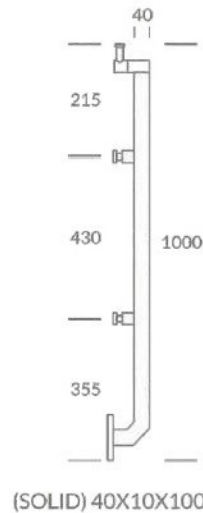

02S020

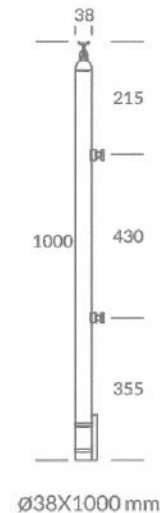

02S021

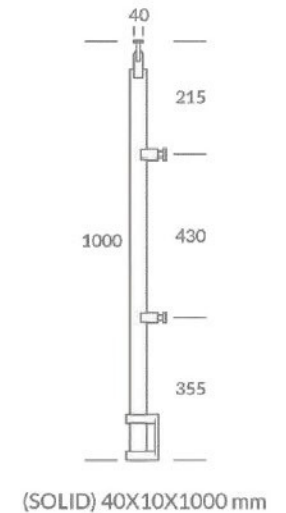



Balusters

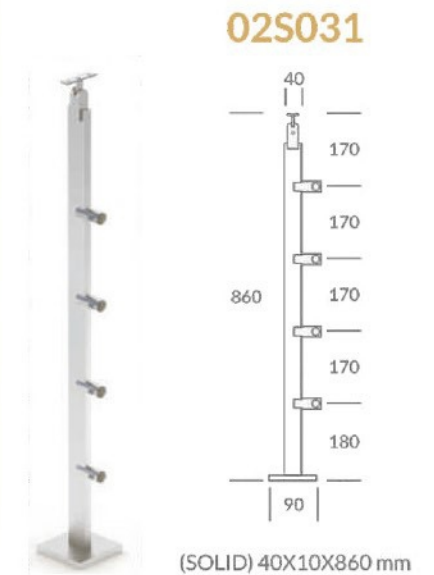
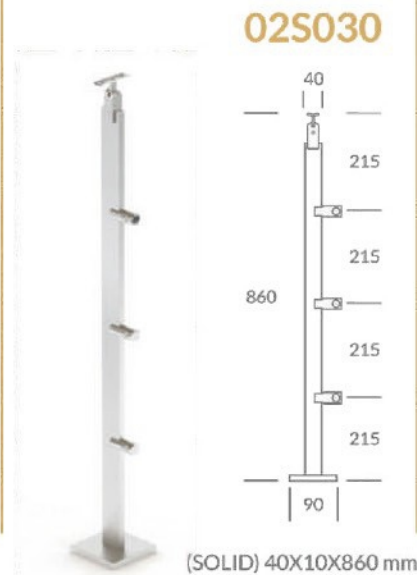
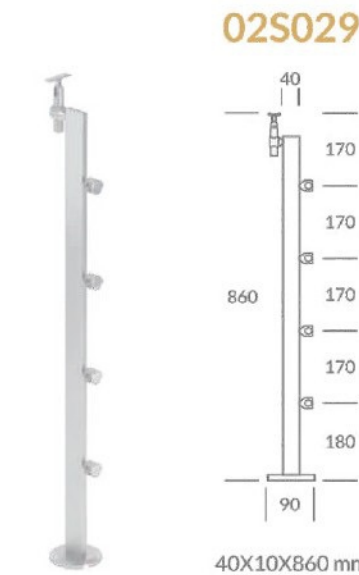
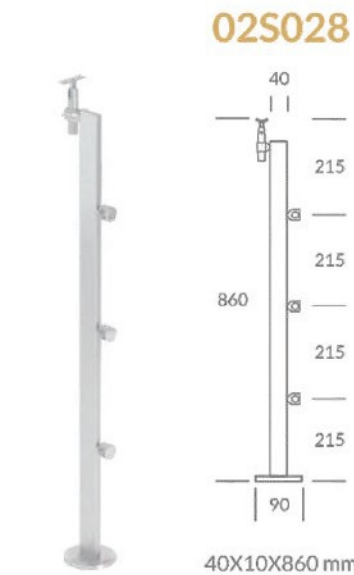
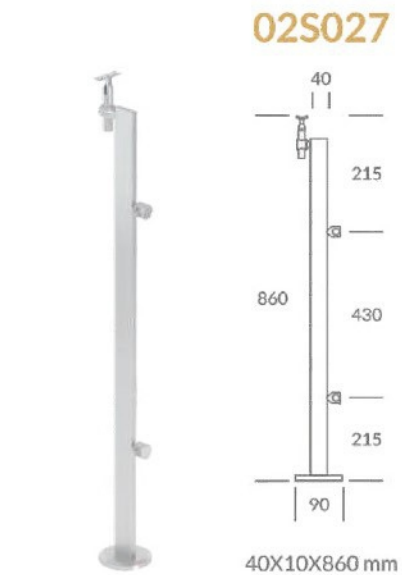
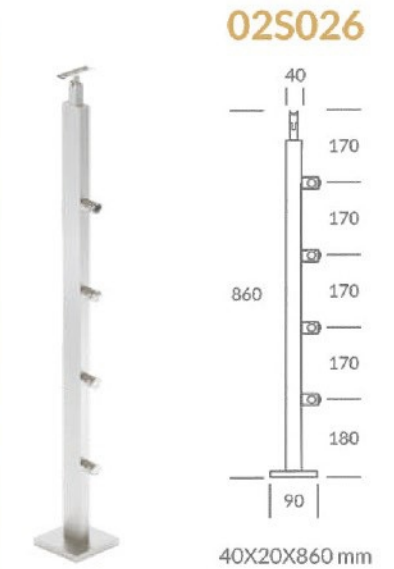
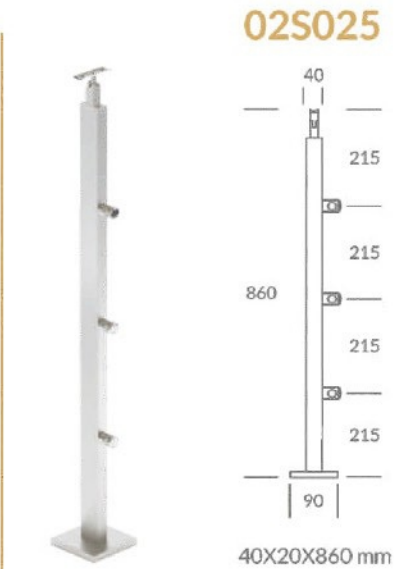
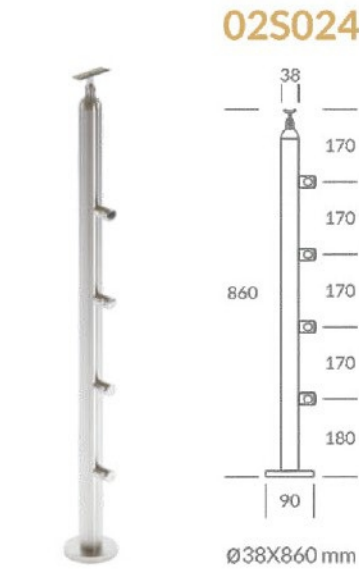
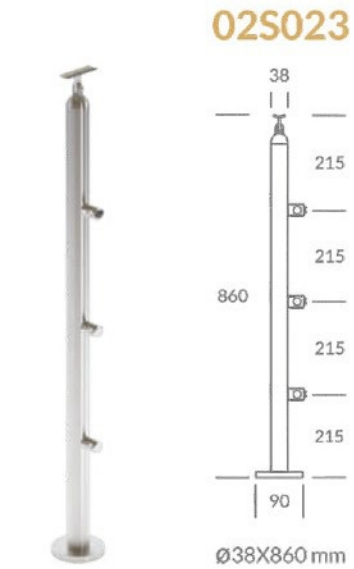
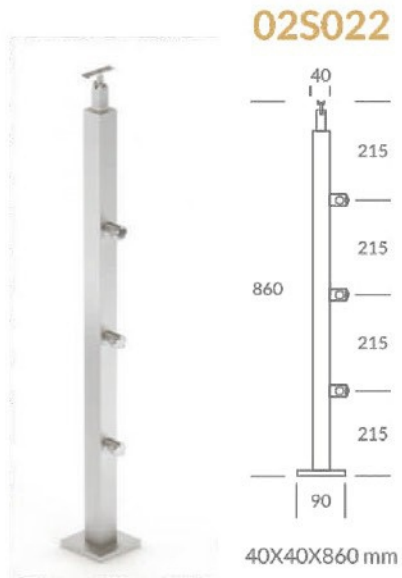



Handrail Brackets

03S001



03S002



03S003



03S004



03S005



03S006



03S007



03S008



03S009



03S010



03S011



03S012



03S013



03S014



03S015



03S016



03S017











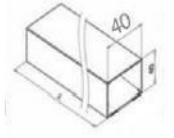





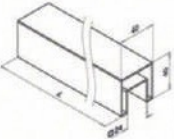





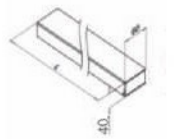





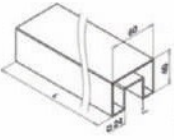



03S018

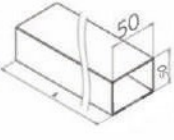

| | HANDRAIL | SIZE | UNI. BEND | 90° BEND | WALL CONCEAL | JOINTER | END CAP |
|----------|-------------------------------------------------------------------------------------|-----------------------------------------------------------------------------------------------|--------------------------------------------------------------------------------------------|----------------------------------------------------------------------------------------------|----------------------------------------------------------------------------------------------|----------------------------------------------------------------------------------------------|----------------------------------------------------------------------------------------------|
| 04 S 001 |  |  Ø38 mm |  (a) |  (b) |  (c) |  (d) |  (e) |
| 04 S 002 |  |  Ø42 mm |  (a) |  (b) |  (c) |  (d) |  (e) |
| 04 S 003 |  |  Ø42 mm |  (a) |  (b) |  (c) |  (d) |  (e) |
| 04 S 004 |  |  Ø50 mm |  (a) |  (b) |  (c) |  (d) |  (e) |
| 04 S 005 |  |  Ø16 mm |  (a) | — (b) | — (c) |  (d) |  (e) |

Steel Handrails

| | HANDRAIL | SIZE | UNI. BEND | 90° BEND | WALL CONCEAL | JOINTER | END CAP |
|----------|-------------------------------------------------------------------------------------|-------------------------------------------------------------------------------------------------------|--------------------------------------------------------------------------------------------|----------------------------------------------------------------------------------------------|----------------------------------------------------------------------------------------------|----------------------------------------------------------------------------------------------|----------------------------------------------------------------------------------------------|
| 04 S 006 |  |  40 x 40 mm |  (a) |  (b) |  (c) |  (d) |  (e) |
| 04 S 007 |  |  40 x 40 mm SLT |  (a) |  (b) |  (c) |  (d) |  (e) |
| 04 S 008 |  |  60 x 40 mm |  (a) |  (b) |  (c) |  (d) |  (e) |
| 04 S 009 |  |  60 x 40 mm SLT |  (a) |  (b) |  (c) |  (d) |  (e) |
| 04 S 010 |  |  50 x 50 mm |  (a) |  (b) |  (c) |  (d) |  (e) |





BRAND OF **IMPERIAL**
HARDWARE

SHOP No. 4, GROUND FLOOR, GOKULDHAM CHS,
32, KIKA STREET, GULAWADI, MUMBAI 400004.
EMAIL: WEASSIST@DIOSINDIA.IN
WEBSITE: WWW.DIOSINDIA.IN

CONNECT WITH US

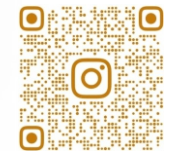

@ DIOS.INDIA